

Revision Notes.				
R1 -				
APA: -	Drawn:-	Checked:-	Approved:-	Date: -

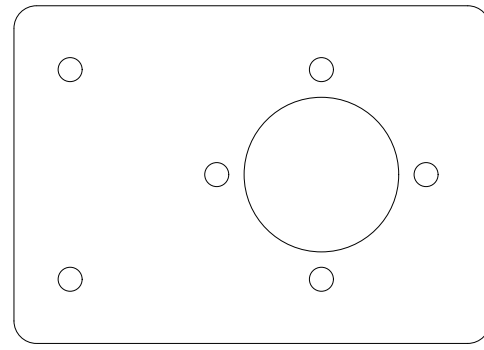

- NOTES:
1. MATERIAL: ALUMINUM
  2. FINISH: NATURAL
  3. ALL BURRS AND SHARP EDGES TO BE REMOVED

**PROPRIETARY NOTICE**  
 THIS DESIGN AND TECHNICAL INFORMATION APPEARING ON THIS DRAWING IS THE PROPERTY OF BRIGADE ELECTRONICS, AND IS DISCLOSED IN CONFIDENCE. IT IS NOT TO BE COPIED, REPRODUCED, REVEALED TO OR EXPROPRIATED BY OTHERS, EITHER IN WHOLE OR IN PART WITHOUT THE EXPRESS WRITTEN CONSENT OF BRIGADE ELECTRONICS.

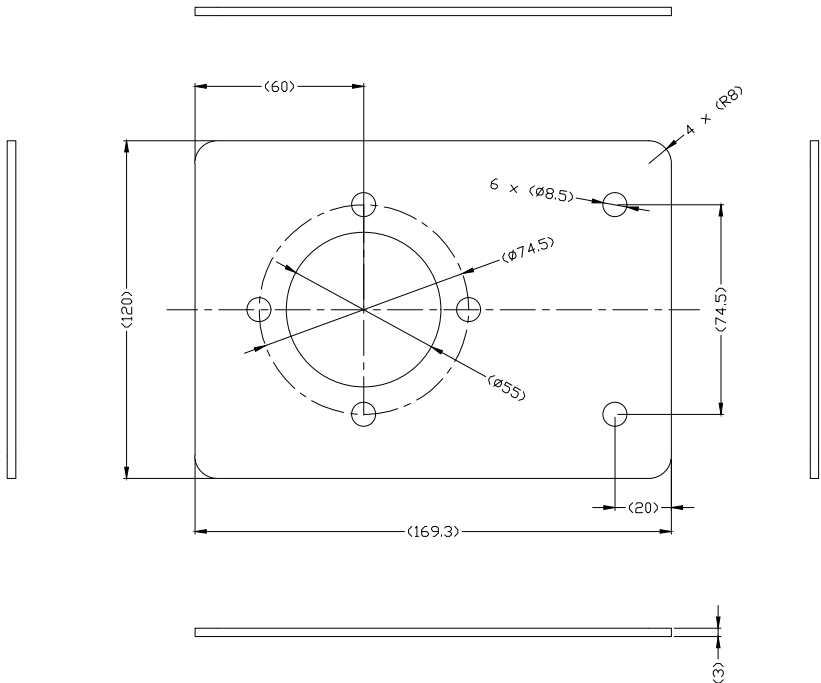
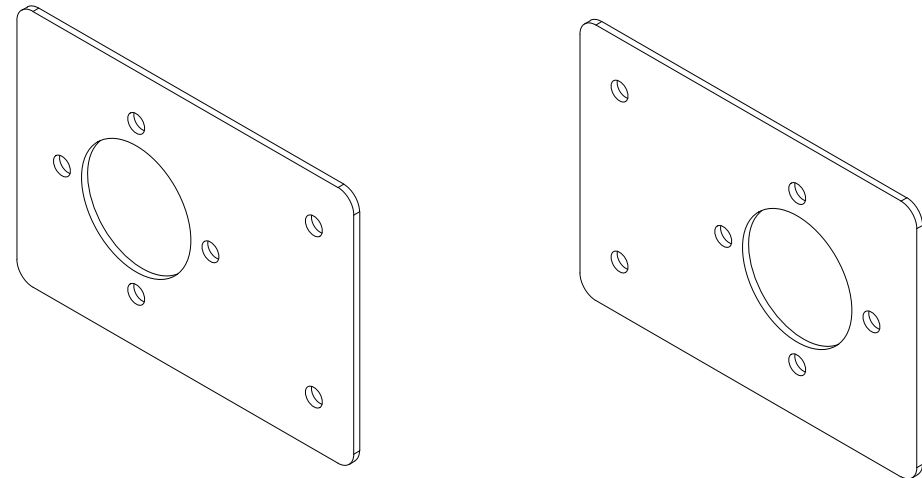

Assembly PI Approval Z.DANIELS 22/11/17		Approved by B.CHILDS		Checked by M.ZAMUIDA		Drawn by D.RICHARDSON	
Angle of Projection Third Angle		Units mm	Scale N/A	Released 23/11/17	Assembly Ref -		
		Status RELEASED		BKT-022			
		Part No 5377		BE-003749-00-17			